

NEW CONSTRUCTION WALL DETAILS

# L&L SAVER SYSTEM™ FP **INSTALLATION INSTRUCTIONS**

Call Toll Free: 800-747-5385  
[www.linsulation.com](http://www.linsulation.com)



# L&L SAVER SYSTEM™ FP INSTALLATION INSTRUCTIONS FROM L&L INSULATIONS

## INTRODUCTION

Born out of a successful contracting business, Thermal Design brought together practical methodology and cost efficient materials to solve the problems of insulating pre-engineered buildings. With well over 40,000 installations to date, our systems are still being improved with superior quality control of materials and installation procedures. A new United States Patent was issued covering the use of the L&L Saver System™ FP as a means of providing fall protection for insulation and roofing workmen. Because of the life saving importance, Thermal Design has included this recently patented feature in the standard L&L Saver System™ FP only for use in Zee or Cee shaped purlin buildings without any extra charge. Due to the critical, life-dependent importance of the materials and installation, only legitimate, quality controlled L&L Saver System™ FP materials, installation drawings and instructions should be used. By rights granted under U.S. patent law, only authorized licensed distributors will be allowed to sell the products used in the patented systems.

The content of this manual contains proprietary information, drawings and instructions which are copyrighted and made available for use under the shrink wrap license agreement on the cover or the wrapper of this manual. This manual and associated video tapes, CD's, software and other documents covered under the license agreements remain property of Thermal Design, Inc. and are solely intended for the exclusive use with the legitimate materials and systems of Thermal Design.

We request that all designers and users only allow the purchase of legitimate materials from authorized sources and follow installation drawings and instructions to assure satisfactory performance of the products. We take job site safety very seriously and we expect that no exceptions will be allowed that breaches the integrity of our quality control processes. A persons life could depend on it! Caution! Look-a-like products designed to be sold put workmen and end users at risk of installed product failures. Experience can not be copied!

# L&L SAVER SYSTEM™ FP INSTALLATION INSTRUCTIONS

## FROM L&L INSULATIONS

### TOOLS AND EQUIPMENT REQUIRED

#### Tools:



Screw guns (two recommended, 0-1000 RPM 4.5 amp minimum, three wire)\*



Five-sixteenths inch (5/16") long shank magnetic nutsetter (two recommended plus spares)



Double-grounded, three-wire extension cords as required to reach power source



8-10 self-locking clamps (with pads preferred for clamping fabric in position)



Utility knives with extra blades (minimum of two)



One pair of safety glasses per worker



Extension ladder with tie off



GoJo® Brand cream hand cleaner (regular type dissolves the Simple Saver High Tack Sealant™)



Towels for hand cleaning



25-foot tape measure



Wrenches to fit rafter brace bolts (two sets of two wrenches)



A good quality caulking and caulking gun to seal liner system at junctions of rafters, rafter braces, fasteners, and other trade hangers.

#### Equipment:

Lifts operable from the basket allow installation with one less crew member and normally pay for themselves in production labor savings.

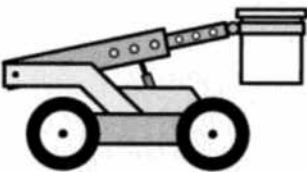

#### Lifts:

- A. Basket type boom lift-best
- B. Scissor lift- OK on solid, level surfaces
- C. Scaffolding

#### Power Generators:

- A. Power Generator or grounded temporary electrical service.



Note: Use scaffolding if automatic lifts are not available. Safety equipment is required for compliance with all applicable State and Federal safety standards. Once the liner system is properly installed and certified it provides the through fall protection for the workers above. CAUTION: Fall protection requires a signed installer agreement. Requires workers be tied off with OSHA compliant safety harness and equipment within six feet of any edge of the L&L Saver System™ FP.

\*When drilling, it is very important to use a variable speed RPM/high torque screw gun. A variable speed DeWalt 269 (DW269) with maximum 0-1000 RPMs is an example of a suitable tool. A variable speed 0-2,500 RPM screw gun may be used, however the electric motor in the screw gun may burn out prematurely due to lower torque ratings. Fastener tips may be ruined by using too high of a speed screw gun for installation. Once the tip of a fastener is ruined it is almost impossible to use.

DO NOT use drywall variable speed screw guns with 0 to 4000 RPM speed as it will simply ruin the fastener tips due to fast heat build-up. Use only screw guns, which have clutches; do not use regular drills as they will torque the heads off the fasteners!

# L&L SAVER SYSTEM™ FP INSTALLATION INSTRUCTIONS

## FROM L&L INSULATIONS

### FAST-R™ HANGER INSTRUCTIONS

Fast-R™ hangers have been developed to quickly hang blanket fiberglass wall insulation. They are pre-cut metal strips with barbed arrows punched into them every 8" on center. These special hangers are shipped in boxes of 80 pieces, which will cover approximately 1,000 sq. ft. with girts spaced 48"-96" apart.

*(Narrow girt spaces, such as 24", may not require hangers if insulation will support itself.)*

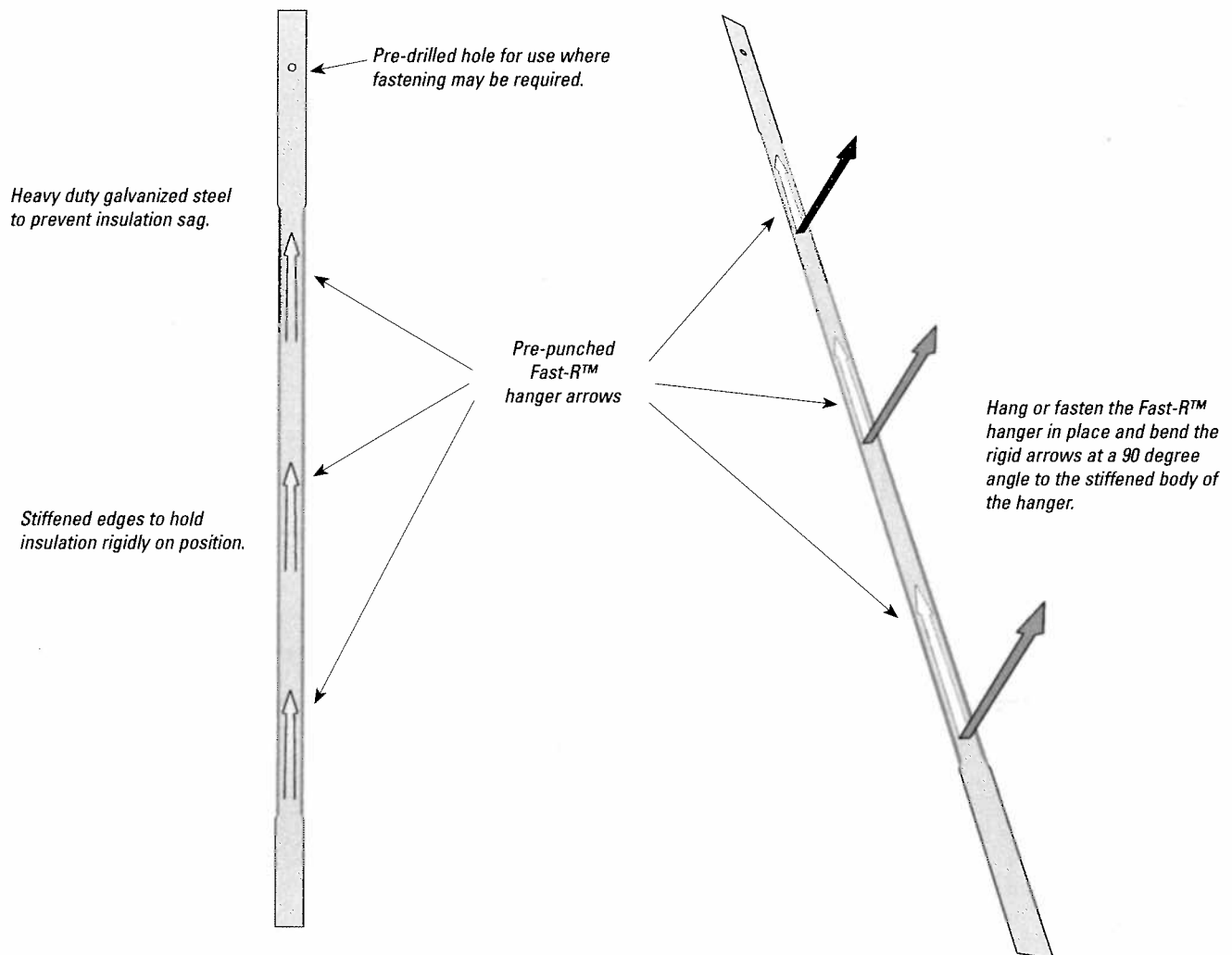

# L&L SAVER SYSTEM™ FP INSTALLATION INSTRUCTIONS

## FROM L&L INSULATIONS

### FAST-R™ HANGER INSTRUCTIONS

**Step 1:** Start at one end of the wall area to be insulated. Remove a Fast-R™ hanger from the box and bend the three barbed arrows perpendicular (90°) to the main body of the hanger. From the interior of the building, slide the top end of the hanger upward between the girt and the tight wall panel until the end protrudes above the girt lip approximately 1.5". Do not install in corrugations of the panels! In some instances fastening may be required. Bend this protruding end sharply inward around the girt lip to secure the Fast-R™ hanger, respectively. Typically two hangers are placed per 60" or 72" insulation blanket width or symmetrically, 30" to 36" apart, respectively. Ideally, hangers positioned 15" or 18" from each side of the blanket, respectively. If any part of the building structure does not allow the above hanging process, simply fasten the hanger to an appropriate structure with a suitable fastener.

**Figure 3-1.**

*Tip: Bending a 1" long, sharp backward bend in the Fast-R™ hanger and sliding it up behind the eave strut allows the hanger to hook on top of the steel wall panel and saves time.*

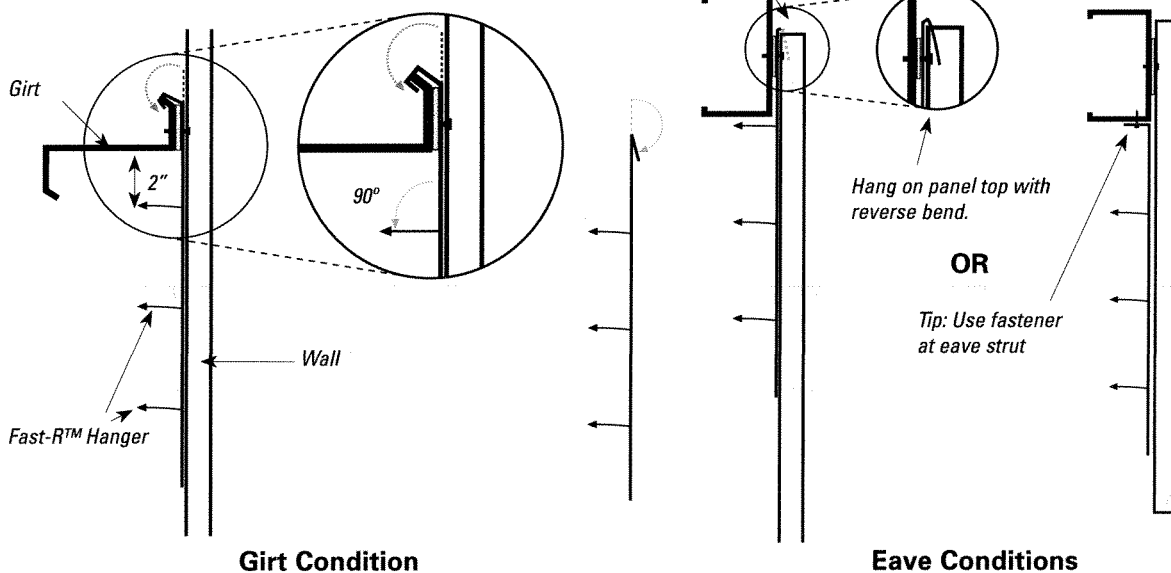

# L&L SAVER SYSTEM™ FP INSTALLATION INSTRUCTIONS

## FROM L&L INSULATIONS

### INSTALLING THE INSULATION

**Step 2:** Cut the insulation to fit exact height between girts, plus one inch extra. Shake the insulation to required thickness recovery the specified product. Carefully lift up the insulation blanket into position setting the bottom of the insulation into the insulation space first, then stand the insulation up against the wall surface and impale it on the barbed arrows. Bend the arrow heads up to lock insulation in position starting at the top arrow and gently pull and fluff the insulation to required thickness around the rigid supporting arrows. Insure that there are no gaps between the insulation and the girts nor any gaps between insulation batts. Repeat this process in all wall areas until completed.

*Quik-Stop™ thermal break or Snap-R® thermal blocks are recommended and preferred between all wall panels and the girt flanges. Installing thermal break materials on the interior girt flanges is a second option.*

**Figure 3-2.**

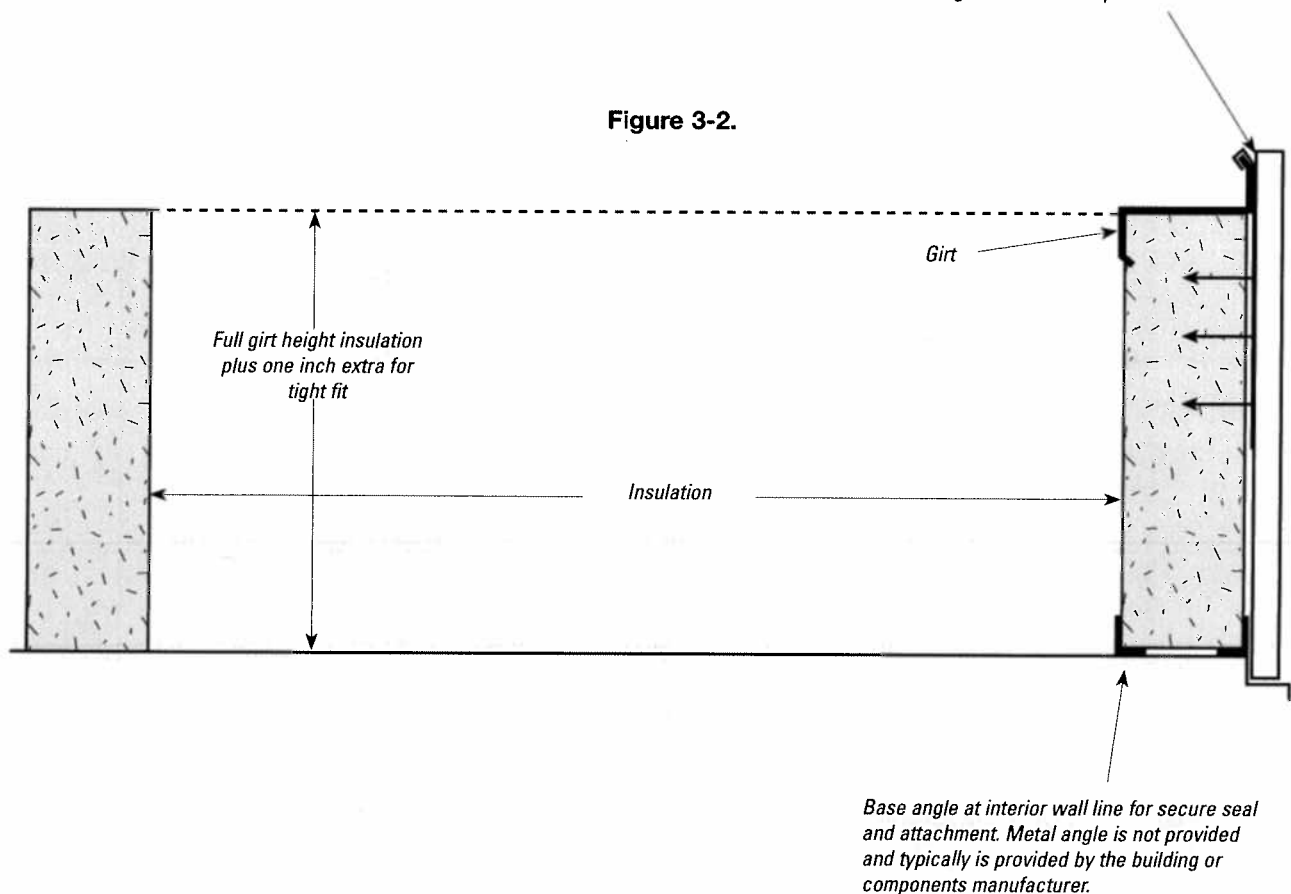

# L&L SAVER SYSTEM™ FP INSTALLATION INSTRUCTIONS

## FROM L&L INSULATIONS

### EAVE LINE STRAP INSTALLATION

**Step 3:** If the eave line strap was not installed along with the longitudinal roof straps, it must now be installed below the traverse ceiling straps from end wall to end wall, or rafter to rafter. Cut the eave line strap the length of the building or bay (e.g. 20 feet for 20 feet long bay spacing) and install it plumb with the inside plane of the girts.

Figure 3-3.

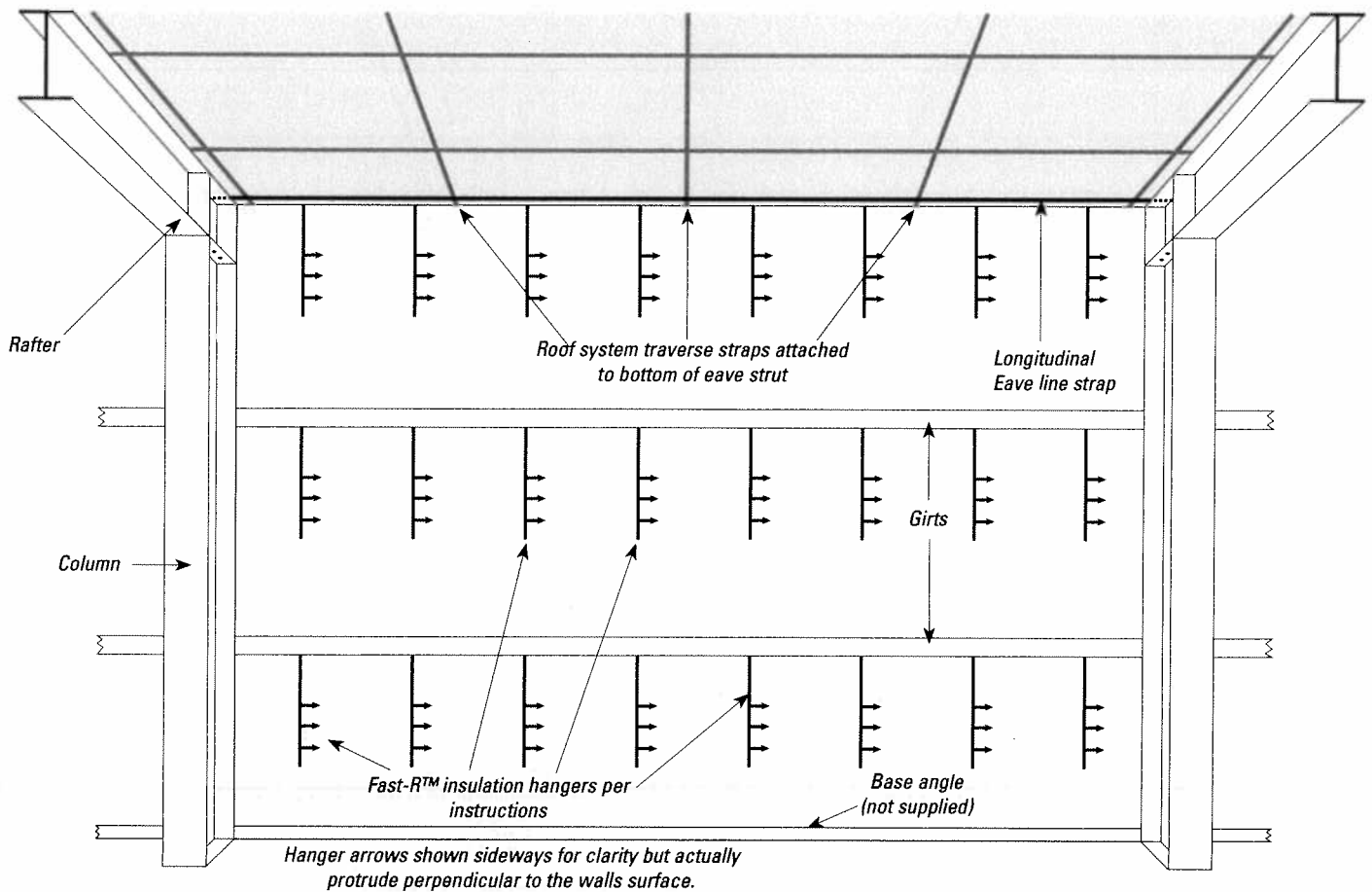

Thermal Design recommends applying a minimum 3/16" thick Quik-Stop™ self-adhering thermal break to the outside of girts, jambs and headers before applying wall sheets and/or between the interior flanges and the wall liner fabric to reduce conductive heat transfer. Snap-R® thermal blocks may be used for greater thickness on the interior of the girts to create the desired insulation depth space.

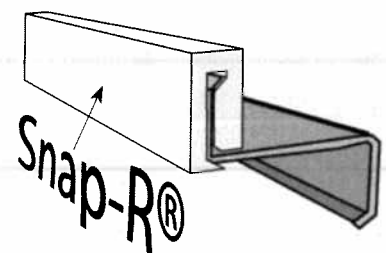
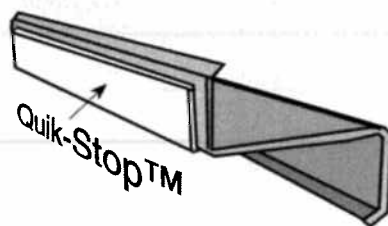

# L&L SAVER SYSTEM™ FP INSTALLATION INSTRUCTIONS

## FROM L&L INSULATIONS

### NEW WALL SYSTEM INSULATION IN STEEL FRAME BUILDINGS

Figure 3-4.

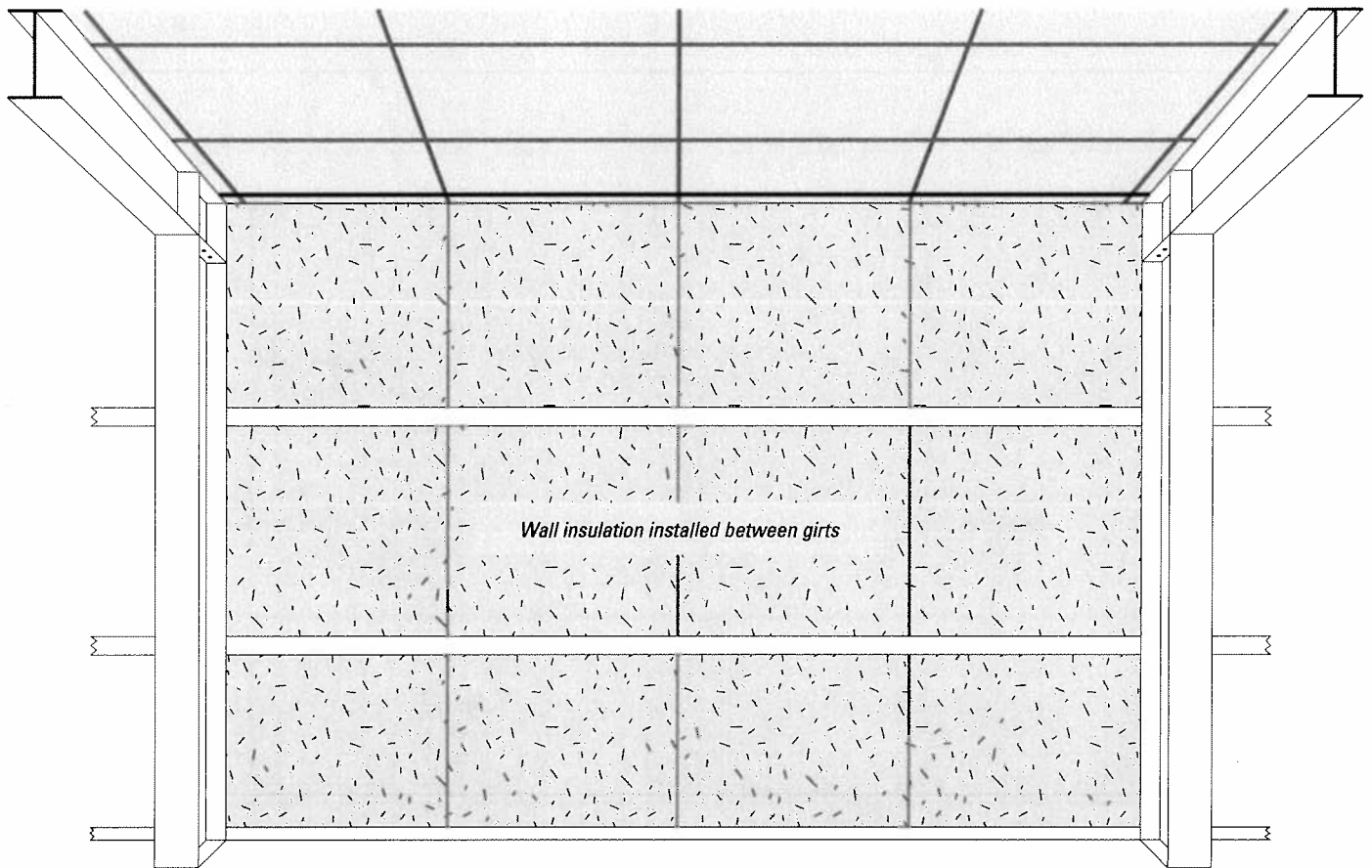

Cut the insulation to the proper lengths, shake each piece to the required thickness and impale it squarely between the girts on the rigid Fast-R™ hanger arrows. Abut the insulation joints tightly together and leave no gaps on any side. Filling the full depth of the space is critical for optimum performance because of convection currents.

Filling the wall depth with high quality blanket fiberglass insulation will inhibit vertical convection currents and tightly fitting the insulation on all sides will minimize the loss of performance.



# L&L SAVER SYSTEM™ FP INSTALLATION INSTRUCTIONS FROM L&L INSULATIONS

## NEW WALL SYSTEM INSTALLATION IN STEEL FRAME BUILDINGS

**Step 4:** Position appropriate sized Syseal® fabric on wall bay (see project drawings provided with system for the custom sizes made to fit each defined wall section). Start positioning the wall fabric in the left inside corner at the rafter and eave line strap intersection. Tip: It helps to fold the side fabric edge back on top of itself the column flange width plus 2" while clamping the fabric over the eave line strap. Position the wall fabric behind, up and around the eave line strap toward the building interior by 3" and temporarily clamp it in this exact position. Allow sufficient fabric to the side to seal the fabric all the way to the column web on each side and have at least 2" of side trim. (At least 2" are allowed by Thermal Design for this trim.) Proceed laterally toward the opposite inside corner of this eave line bay, positioning the wall liner fabric behind, up and around the eave line strap by the 3", temporarily clamping the wall fabric squarely in position between the eave line strap and each overlying traverse ceiling strap (see Figure 3-5).

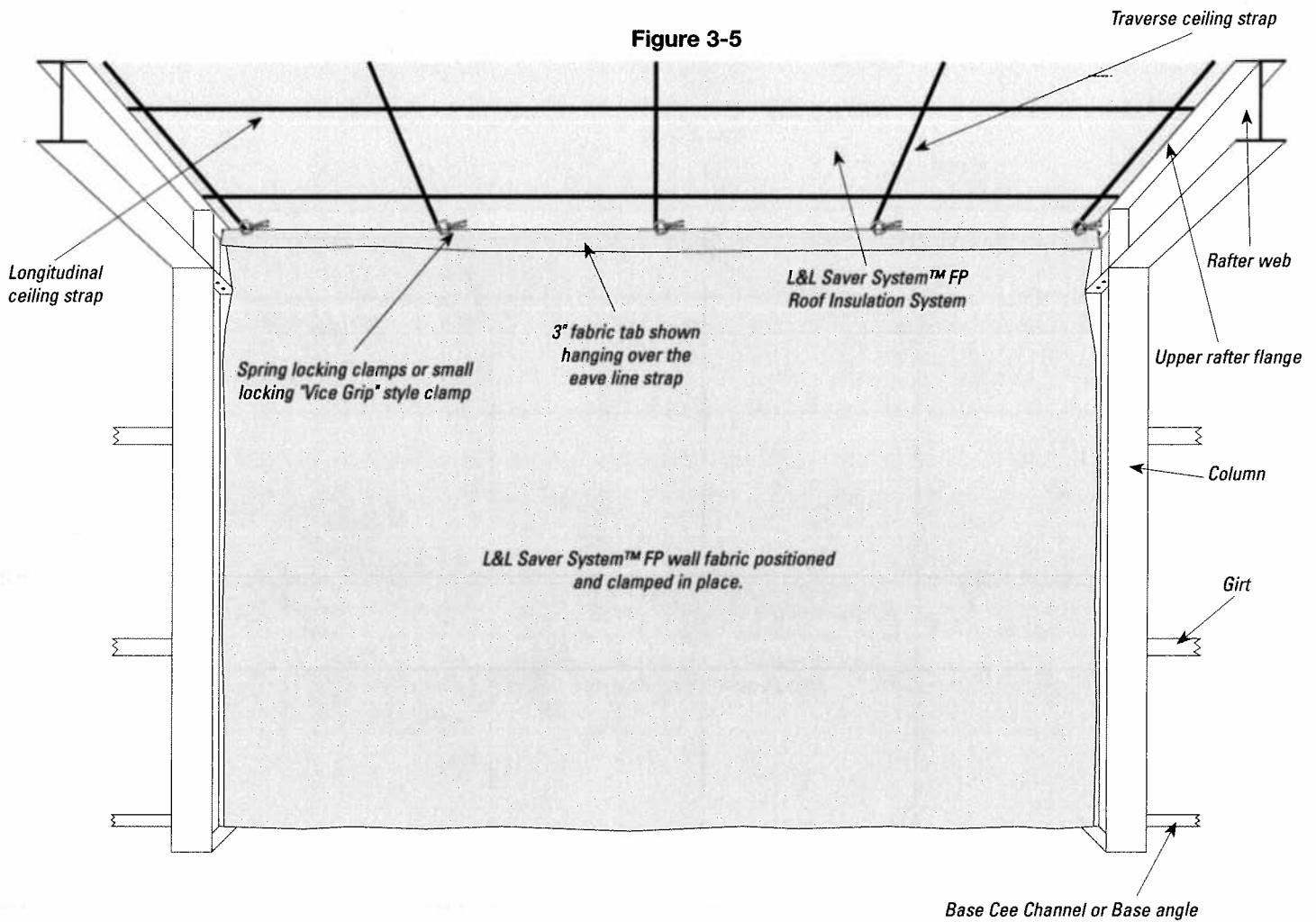

# L&L SAVER SYSTEM™ FP INSTALLATION INSTRUCTIONS FROM L&L INSULATIONS

## NEW WALL SYSTEM INSTALLATION IN STEEL FRAME BUILDINGS

**Step 5:** Cut the number of vertical wall straps required: usually about every five feet (see Thermal Design project drawings for spacings). Straps shall reach from ceiling to floor plus 8" extra. Install wall retaining straps by drilling self drilling screws through the wall strap, about 3" from the top end; then fasten through the eave line strap, and then to the overlying wall fabric and into the traverse ceiling strap, thereby fastening them all together. Remove temporary clamps upon each permanent fastening. Also install a steel retention strap vertically, along the column flange to mechanically fasten the edge conditions for permanency.

**Step 6:** Seal Syseal® Sticky Tape to this upper side of the wall fabric 3" tab. Then neatly bond this upper wall fabric edge to the ceiling fabric up-slope from the eave line strap. (See Figure 3-8.) Hint: Installing a small piece of Syseal® Sticky Tape between the traverse ceiling strap and the ceiling fabric prior to bonding the fabric edge insures that this small condition is also effectively sealed above the strap.

Figure 3-6.

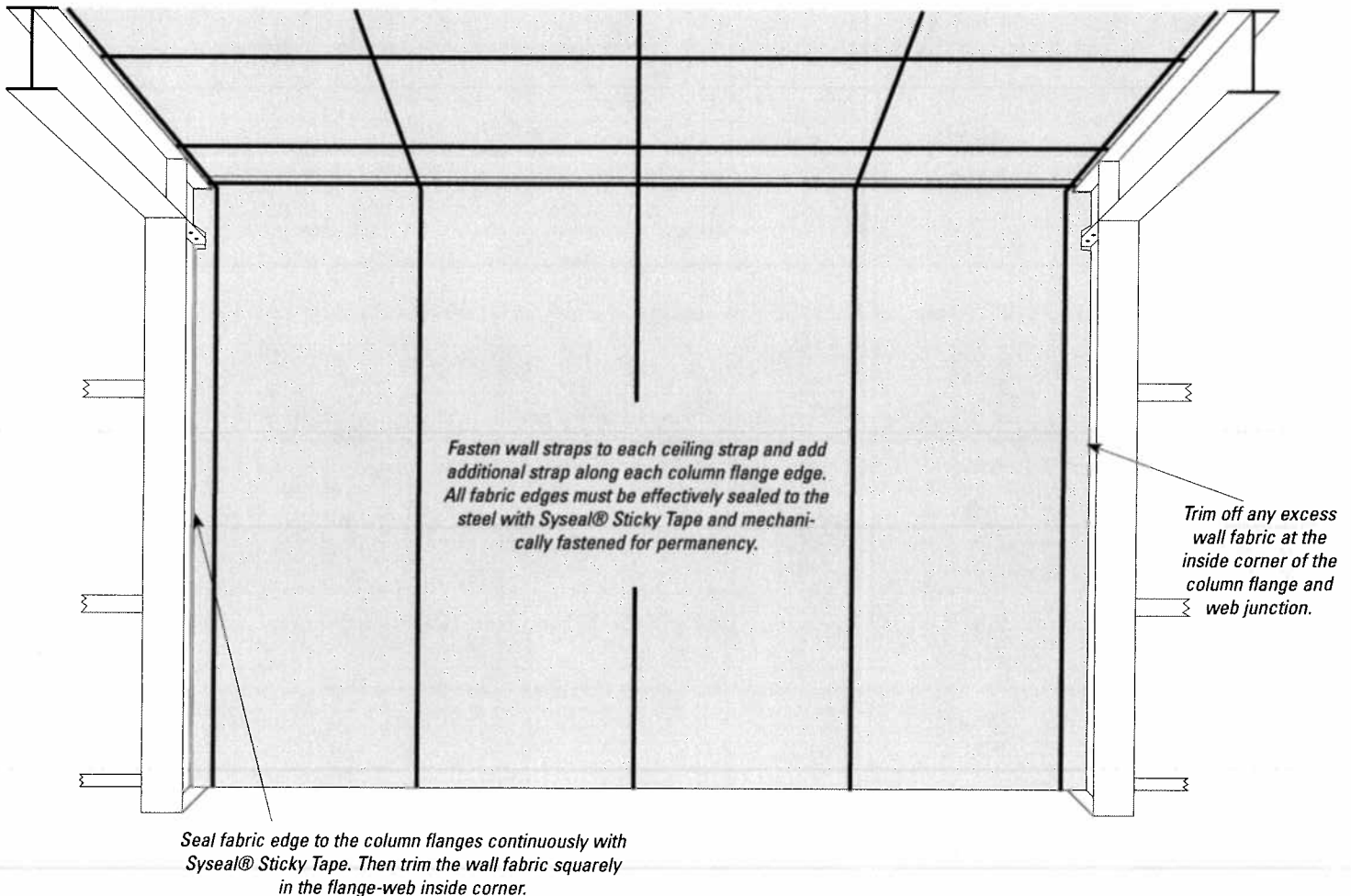

# L&L SAVER SYSTEM™ FP INSTALLATION INSTRUCTIONS

## FROM L&L INSULATIONS

### NEW WALL SYSTEM INSTALLATION IN STEEL FRAME BUILDINGS

**Step 7:** Install Syseal® Sticky Tape or the Simple Saver High Tack Sealant™ continuously along the base angle near the floor and up the column flanges near the inside corner of the column web to column flanges. Allow to get very tacky. Beginning in the center of the wall bay at the base angle, pull the wall fabric straight downward with some tension, and stick the wall fabric under slight tension to the Syseal® Sticky Tape or Simple Saver High Tack Sealant™. Proceed to pull the wall fabric tight and stick it to the base angle laterally to each column web. Then trim the wall fabric squarely in the floor-wall inside corner. It is highly recommended that a sill seal (by others) is installed between the floor foundation and the base structural members. Fasten the wall straps at the base in slight tension and then at each intersection with underlying girts when self-drilling fasteners. Similarly, pull taut and adhere the wall fabric side edges to the column flanges with Simple Saver High Tack Sealant™ or Syseal® Sticky Tape, trim off any excess fabric at the inside corners. With some tension, fasten the lower end of the side edge straps to the base and then fasten at each intermediate girt location. Refer to installation sketches with these instructions.

Figure 3-7.

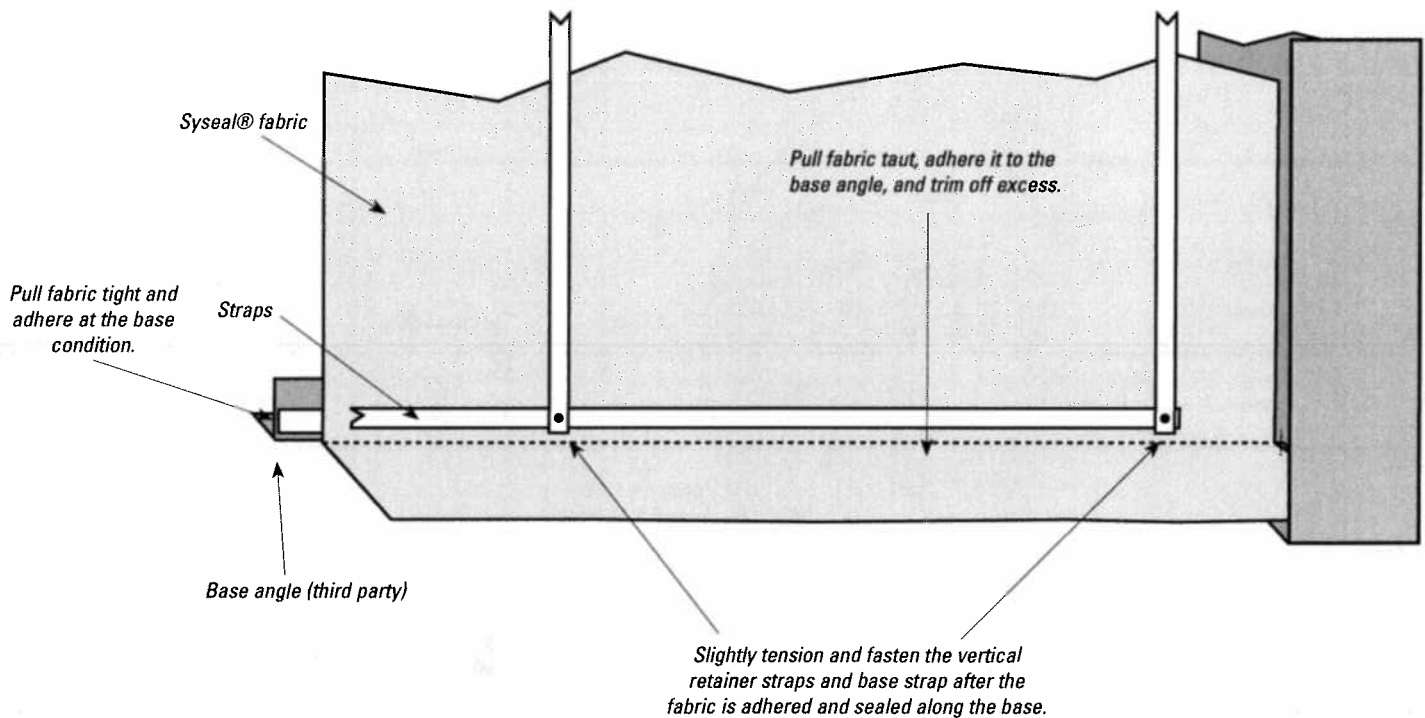

# L&L SAVER SYSTEM™ FP INSTALLATION INSTRUCTIONS FROM L&L INSULATIONS

## PROPER INSTALLATION OF WALL STRAPS

Figure 3-8.

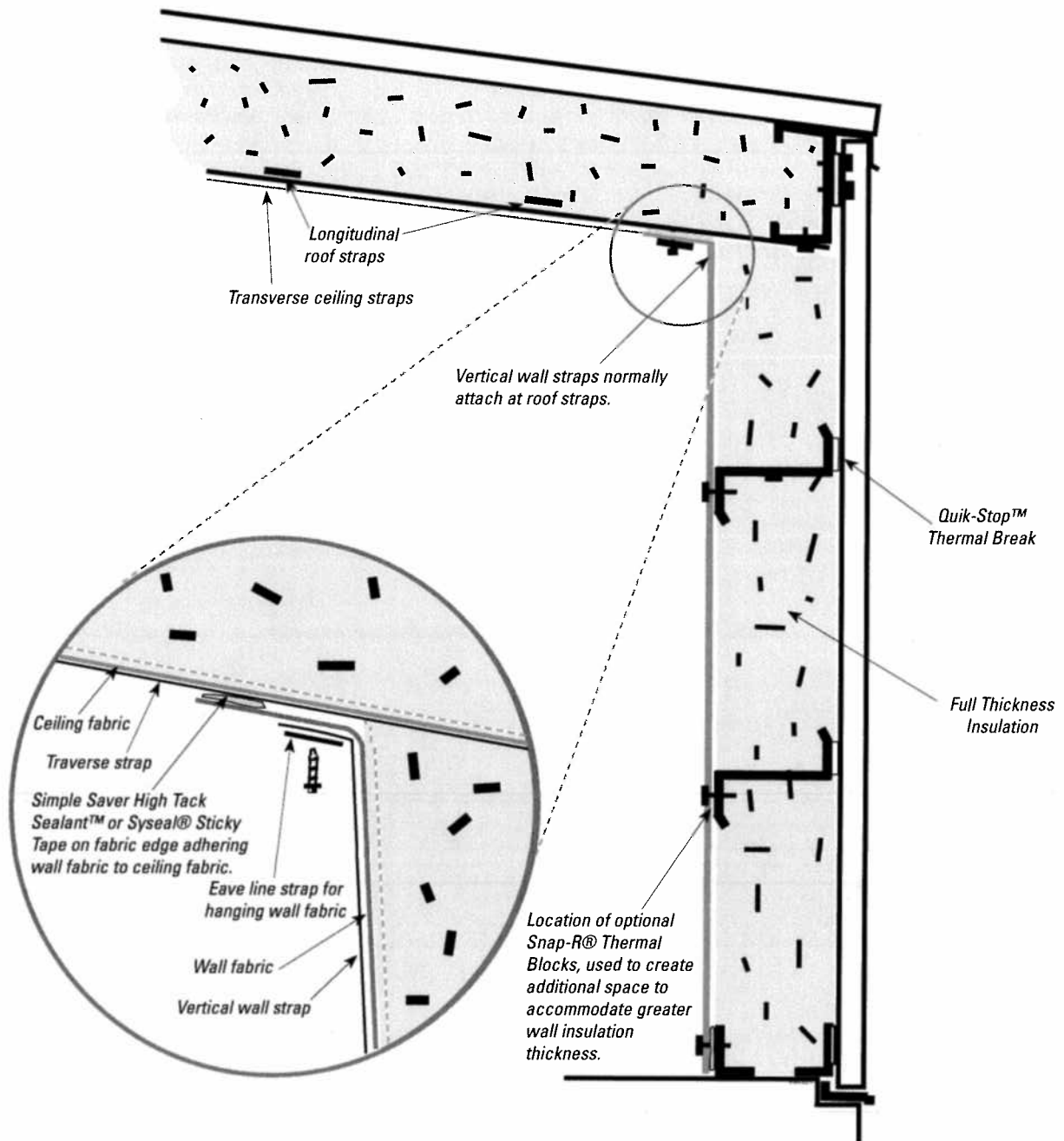

# L&L SAVER SYSTEM™ FP INSTALLATION INSTRUCTIONS FROM L&L INSULATIONS

## SINGLE-LAYER WALL SYSTEM INSULATION IN STEEL FRAME BUILDINGS

Figure 3-9.

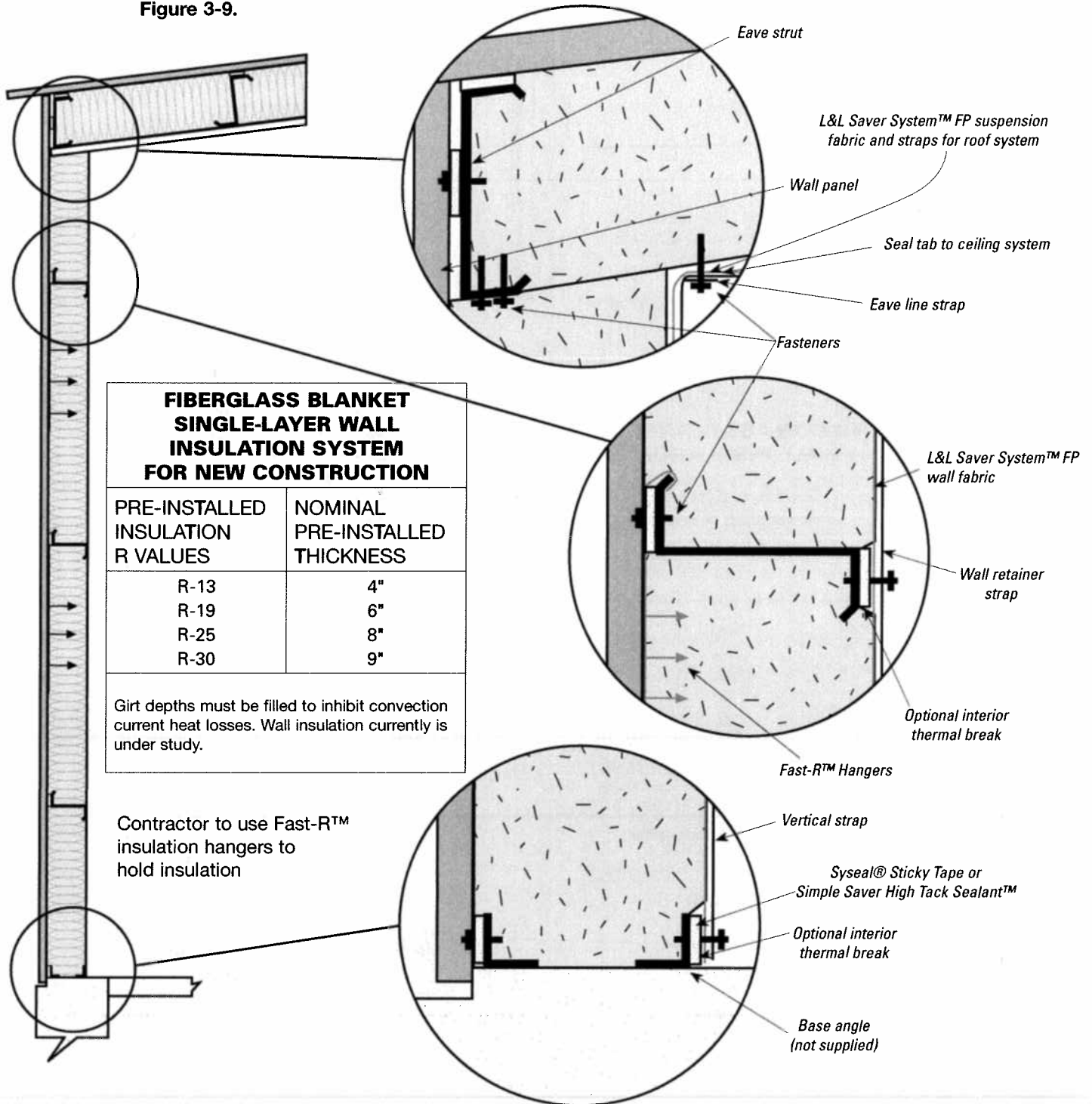

Notice: Vertical wall system performances are currently under research investigation.

# L&L SAVER SYSTEM™ FP INSTALLATION INSTRUCTIONS FROM L&L INSULATIONS

## DOUBLE-LAYER WALL INSULATION SYSTEM FOR STEEL FRAMED BUILDINGS

Figure 3-10.

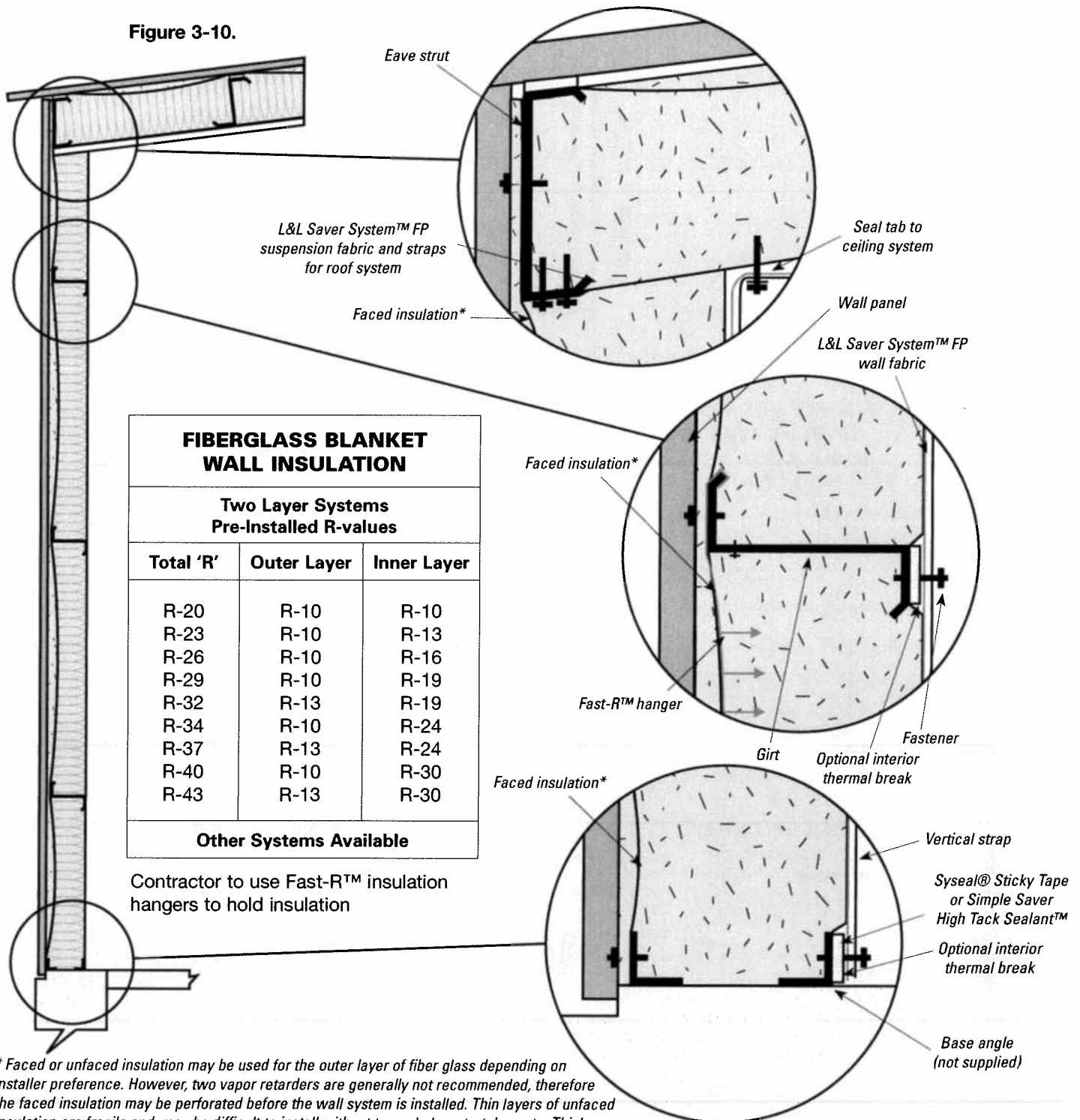

FIBERGLASS BLANKET WALL INSULATION		
Two Layer Systems Pre-Installed R-values		
Total 'R'	Outer Layer	Inner Layer
R-20	R-10	R-10
R-23	R-10	R-13
R-26	R-10	R-16
R-29	R-10	R-19
R-32	R-13	R-19
R-34	R-10	R-24
R-37	R-13	R-24
R-40	R-10	R-30
R-43	R-13	R-30
Other Systems Available		

Contractor to use Fast-R™ insulation hangers to hold insulation

\* Faced or unfaced insulation may be used for the outer layer of fiber glass depending on installer preference. However, two vapor retarders are generally not recommended, therefore the faced insulation may be perforated before the wall system is installed. Thin layers of unfaced insulation are fragile and may be difficult to install without tears, holes, stretches, etc. Thick single layers of fiberglass are generally recommended with thermal breaks on girts.

Notice: Vertical wall system performances are currently under research investigation.

# L&L SAVER SYSTEM™ FP INSTALLATION INSTRUCTIONS FROM L&L INSULATIONS

## SECTIONAL DETAIL AT GIRT-TO-COLUMN CONNECTION

Figure 3-11.

### Outset Girt Condition (Exterior Mounted Girts)

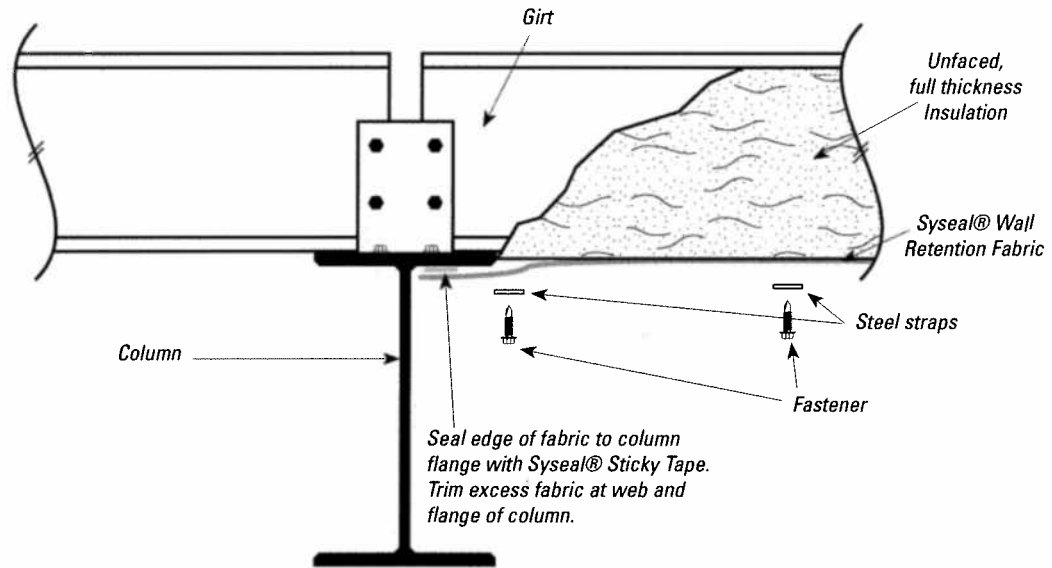

### Inset Girt Condition

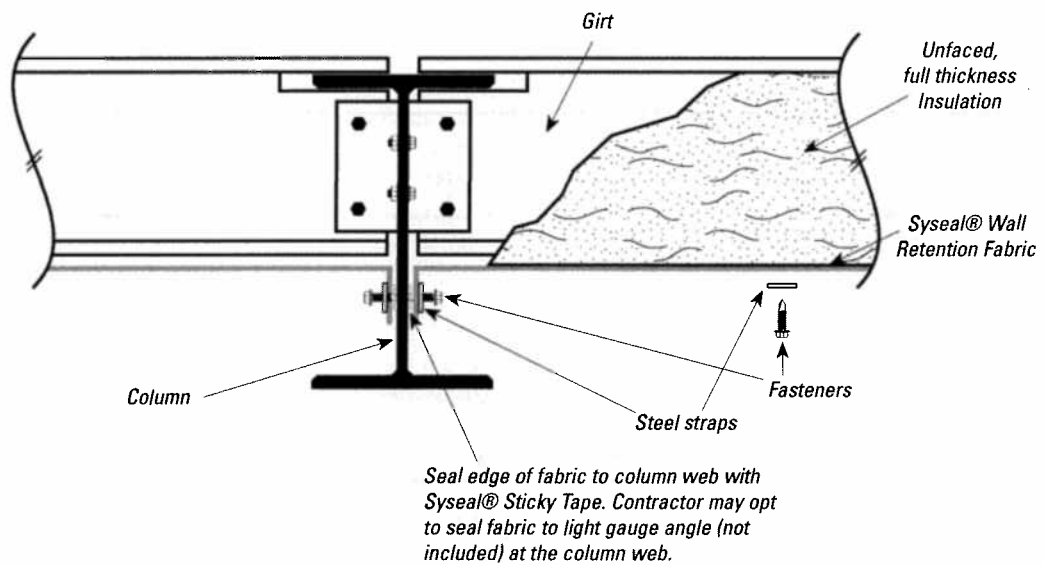

# L&L SAVER SYSTEM™ FP INSTALLATION INSTRUCTIONS FROM L&L INSULATIONS

## SECTIONAL DETAIL AT END RAFTER TO END WALL CONNECTION

Figure 3-12.

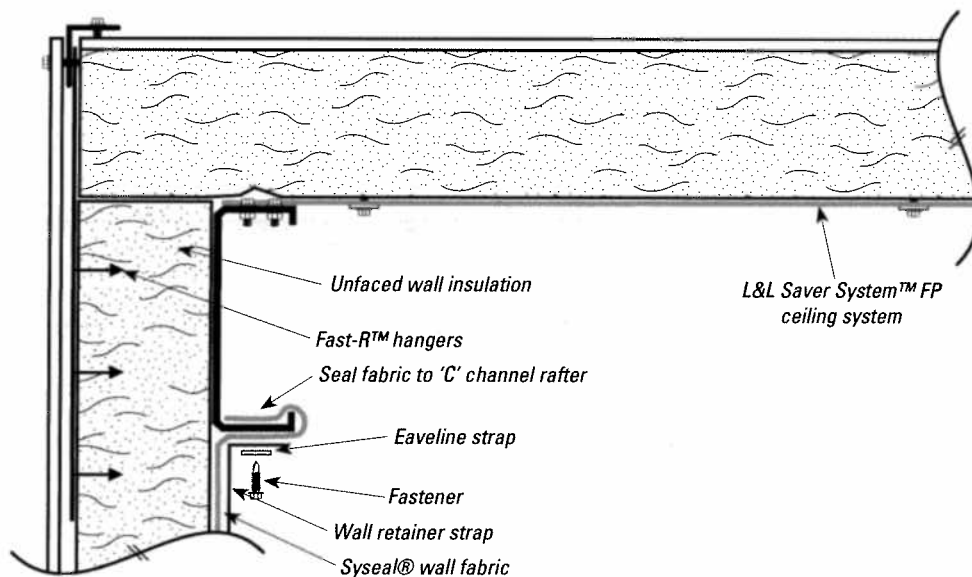
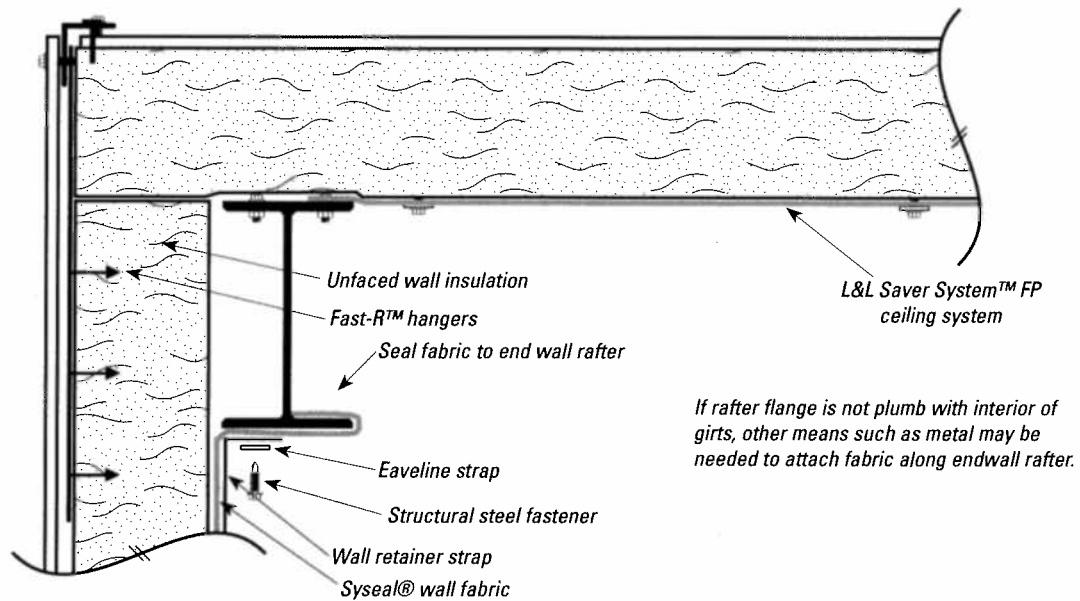

*Note: Various building lines have different structural details and may be different than these shown. Call 800-747-5385 for recommendations.*



# L&L SAVER SYSTEM™ FP INSTALLATION INSTRUCTIONS

## FROM L&L INSULATIONS

### SPECIAL EAVE AND WALL DETAILS

The detail to the right shows how a conventional pre-engineered wall with normal sized girts can be well insulated using the L&L Saver System™ FP. Either hat channels or steel studs can be installed vertically on 16" or 24" centers and the drywall applied to them.

When using hat channels it might be necessary to specify an intermediate girt in the lower seven foot (or more) girt span when ordering the building to provide adequate support for the lighter channels.

All the electric, phone and computer wires can be placed in the open hat channel/steel stud cavity created along with the receptacle boxes. This allows the integrity of the vapor barrier to be maintained, unlike a standard stud wall that is full of subcontractors installations. *(Note: Wires can run horizontally between the vapor retarder and studs by simply pushing in on the vapor retarder.)*

Limited holes can be drilled in the column webs (and in limited numbers) for the horizontal running wires. Contact your building manufacturer for limitations. Conduits and pipes may simply be run behind the columns through the L&L Saver System™ FP liner fabric penetrations then sealed.

### Wall Detail: Full Girt Cavity Insulation

Figure 3-13.

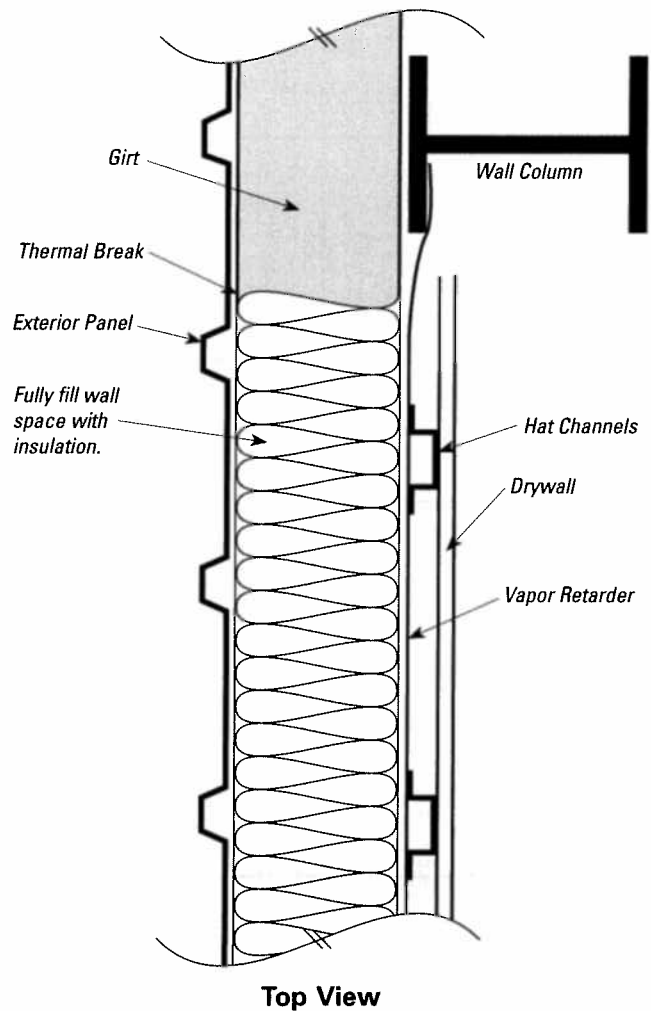

### Special Eave Detail with Angle at Eave

Figure 3-14.

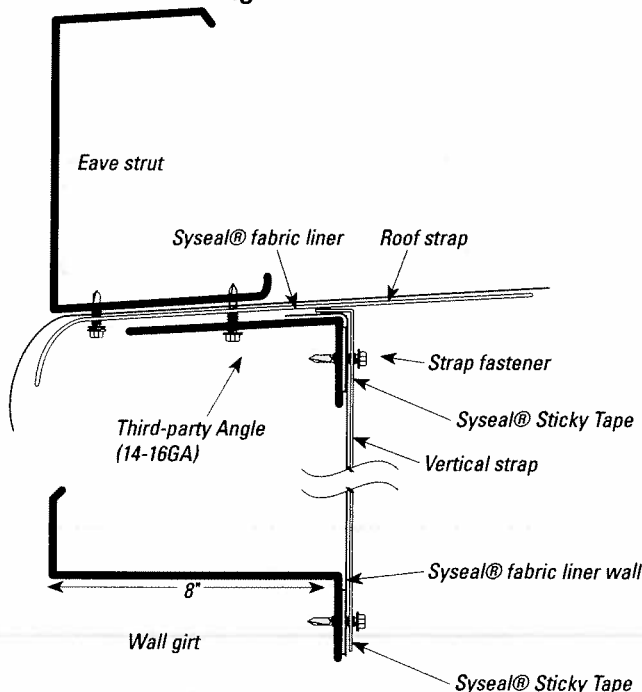

For use if a more finished look is desired where the roof and wall systems adjoin each other. Recommended when roof and wall systems are different colors.

# L&L SAVER SYSTEM™ FP INSTALLATION INSTRUCTIONS FROM L&L INSULATIONS

## INSULATED PARTITION WALL SYSTEM

Figure 3-15.

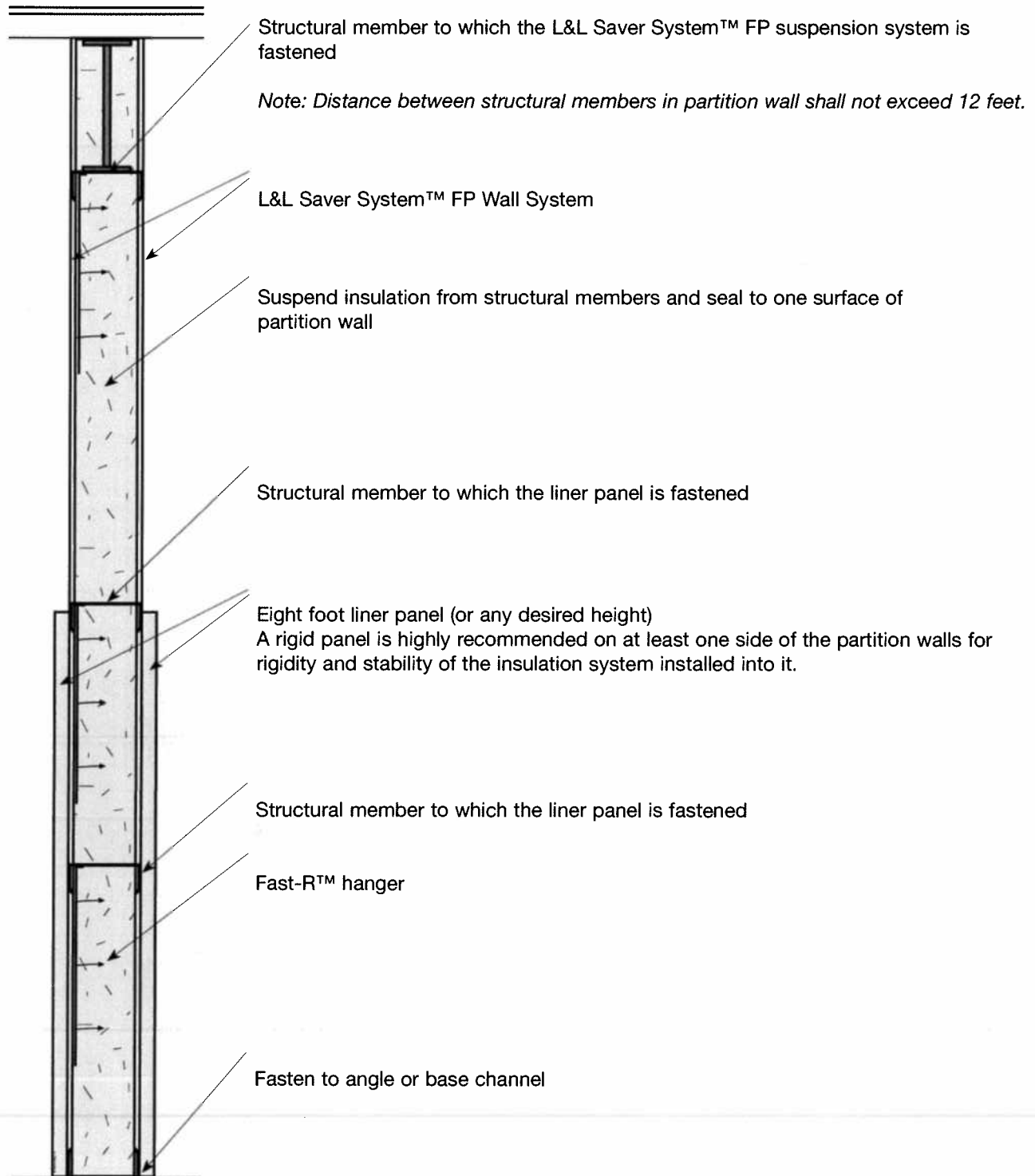

Unauthorized making, using or selling of this patented technology or trademarks or service marks or copyrighted works shall be each subject to a minimum royalty and lost profit per square foot of surface insulated from such unauthorized acts. Sellers of any component with the knowledge or intent that such component is to be used to evade the purchase of legitimate materials from authorized sources shall be held liable as contributory infringers and otherwise as lawful. All costs of collection, including legal fees and costs, shall be sought as damages for unauthorized use and infringement.

L&L Saver System™ FP is not designed or intended to be walked or stood upon. Any such use will void the fall protection certification. The fall protection feature is strictly for accidental falls while insulating and roofing.

To obtain a project fall protection certificate, all system materials must be purchased from an authorized distributor of Thermal Design, Inc. The erectors/installers will be required to thoroughly read the installation instructions and sign the form provided that they have read, understood and agree to install the L&L Saver System™ FP in accordance with the instructions. A copy of the signed form must be received by Thermal Design, Inc. along with a current erector/installer insurance certificate listing Thermal Design a certificate holder and show required coverages of liability, property damage and worker's compensation coverage for the project. The primary limits of the insurance coverage shall be those already provided by the erector/installer to cover their workers and liability. The secondary limits shall be that liability coverage carried by Thermal Design.

Safety lines along the rafters and a safety harness with shock absorbing lanyards must be used while installing the L&L Saver System™ FP liner system for topside workers. A safety harness with lanyard in combination with a suitable lift must be used by bottom-side workers when installing the L&L Saver System™ FP liner system. Once the L&L Saver System™ FP liner is properly installed in the affected building roof area, the through fall protection certificate will become effective for topside workers for subsequent insulation and roof sheeting work. **Workmen must use a safety harness connected to an OSHA compliant lifeline within 6' of any roof edge or liner system edge.**

The L&L Saver System™ FP liner system must be completely installed in each affected building area prior to reliance on the system as an alternative means of fall protection for that area. Only one installation of the L&L Saver System™ FP materials will be allowed per certificate. A copy of the installation instructions and the "Certificate of Alternative Fall Protection" signed by the erector/installer must be prominently posted at the job site as notice to all contractors, workers and inspectors. **Workmen must use a safety harness connected to an OSHA compliant lifeline within 6' of any roof edge or liner system edge.**

---

Copyright © 2012 Thermal Design, Inc.  
PO Box 468, Madison, NE 68748

All rights reserved, including the right of reproduction in whole or in parts in any form.  
All trademarks are property of respective properties.  
L&LSaverSystemFP InstallInstructions.indd PM 01/10/12

